

JVC

SCHEMATIC DIAGRAMS

COLOUR TELEVISION

AV-16N8(VT)

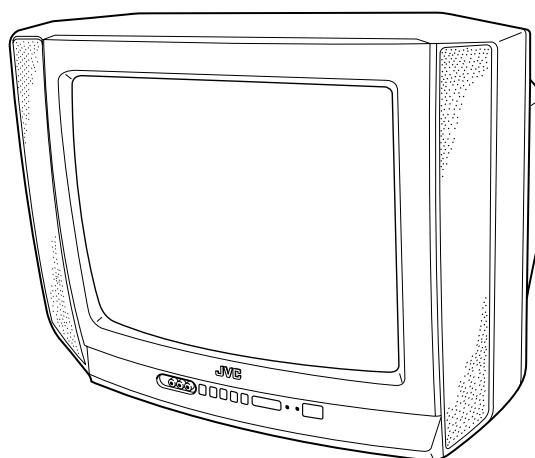
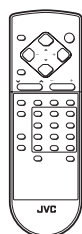

STANDARD CIRCUIT DIAGRAM

NOTE ON USING CIRCUIT DIAGRAMS

1. SAFETY

The components identified by the Δ symbol and shading are critical for safety. For continued safety replace safety critical components only with manufactures recommended parts.

2. SPECIFIED VOLTAGE AND WAVEFORM VALUES

The voltage and waveform values have been measured under the following conditions.

- (1) Input signal : Colour bar signal
- (2) Setting positions of each knob/button and variable resistor : Original setting position when shipped
- (3) Internal resistance of tester : DC 20k Ω /V
- (4) Oscilloscope sweeping time : H \rightarrow 20 μ S/div
: V \rightarrow 5mS/div
: Others \rightarrow Sweeping time is specified.
- (5) Voltage values : All DC voltage values

* Since the voltage values of signal circuit vary to some extent according to adjustments, use them as reference values.

3. INDICATION OF PARTS SYMBOL [EXAMPLE]

- In the PW board : R1209 \rightarrow R209

4. INDICATIONS ON THE CIRCUIT DIAGRAM

(1) Resistors

- Resistance value

| | |
|---------|-----------------|
| No unit | : [Ω] |
| K | : [K Ω] |
| M | : [M Ω] |

- Rated allowable power

| | |
|---------------|----------------|
| No indication | : 1/4 [W] |
| Others | : As specified |

- Type

| | |
|---------------|-----------------------------|
| No indication | : Carbon resistor |
| OMR | : Oxide metal film resistor |
| MFR | : Metal film resistor |
| MPR | : Metal plate resistor |
| UNFR | : Non-flammable resistor |
| FR | : Fusible resistor |

* Composition resistor 1/2 [W] is specified as 1/2S or Comp.

(2) Capacitors

- Capacitance value

| | |
|-------------|--------------|
| 1 or higher | : [pF] |
| less than 1 | : [μ F] |

- Withstand voltage

| | |
|---------------|----------------------------|
| No indication | : DC50 [V] |
| AC indicated | : AC withstand voltage [V] |
| Others | : DC withstand voltage [V] |

* Electrolytic Capacitors

47/50 [Example]: Capacitance value [μ F]/withstand voltage [V]





- Type

| | |
|---------------|-------------------------------------|
| No indication | : Ceramic capacitor |
| MY | : Mylar capacitor |
| MM | : Metalized mylar capacitor |
| PP | : Polypropylene capacitor |
| MPP | : Metalized polypropylene capacitor |
| MF | : Metalized film capacitor |
| TF | : Thin film capacitor |
| BP | : Bipolar electrolytic capacitor |
| TAN | : Tantalum capacitor |

(3) Coils



| | |
|---------|----------------|
| No unit | : [μ H] |
| Others | : As specified |

(4) Power Supply



| | |
|--|-------|
|  | : B1 |
|  | : 12V |
|  | : 9V |
|  | : 5V |

* Respective voltage values are indicated.





(5) Test point

| | |
|---|---------------------------|
|  | : Test point |
|  | : Only test point display |

(6) Connecting method

| | |
|---|-------------------------|
|  | : Connector |
|  | : Wrapping or soldering |
|  | : Receptacle |

(7) Ground symbol

| | |
|---|----------------------------------|
|  | : LIVE side ground |
|  | : ISOLATED (NEUTRAL) side ground |
|  | : EARTH ground |
|  | : DIGITAL ground |

5. NOTE FOR REPAIRING SERVICE

This model's power circuit is partly different in the GND. The difference of the GND is shown by the LIVE (\perp) side GND and the ISOLATED (NEUTRAL) (\neq) side GND. Therefore, care must be taken for the following points.

- (1) Do not touch the LIVE side GND or the LIVE side GND and the ISOLATED (NEUTRAL) side GND simultaneously. If the above caution is not respected, an electric shock may be caused. Therefore, make sure that the power cord is surely removed from the receptacle when, for example, the chassis is pulled out.
- (2) Do not short between the LIVE side GND and ISOLATED (NEUTRAL) side GND or never measure with a measuring apparatus (oscilloscope, etc.) the LIVE side GND and ISOLATED (NEUTRAL) side GND at the same time. If the above precaution is not respected, a fuse or any parts will be broken.

- Since the circuit diagram is a standard one, the circuit and circuit constants may be subject to change for improvement without any notice.

CONTENTS

SEMICONDUCTOR SHAPES 2-4

BLOCK DIAGRAM 2-5

CIRCUIT DIAGRAMS

MAIN PWB CIRCUIT DIAGRAM..... 2-7

CRT SOCKET PWB CIRCUIT DIAGRAM 2-13





PATTERN DIAGRAMS

MAIN PWB PATTERN 2-15

CRT SOCKET PWB PATTERN..... 2-17

SEMICONDUCTOR SHAPES

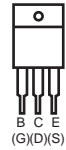
TRANSISTOR

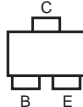
| BOTTOM VIEW | FRONT VIEW | | | | TOP VIEW |
|---|---|---|---|---|--|
|  |  |  |  |  | CHIP TR  |

IC

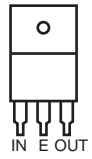
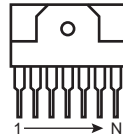
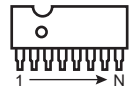
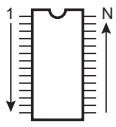
| BOTTOM VIEW | FRONT VIEW | | | TOP VIEW |
|---|---|---|--|---|
|  |  |  |  |  |

CHIP IC

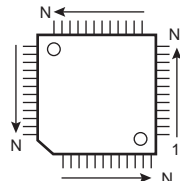
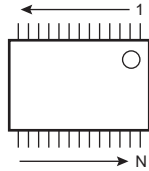
| TOP VIEW | | |
|---|---|--|
|  |  | |

BLOCK DIAGRAM

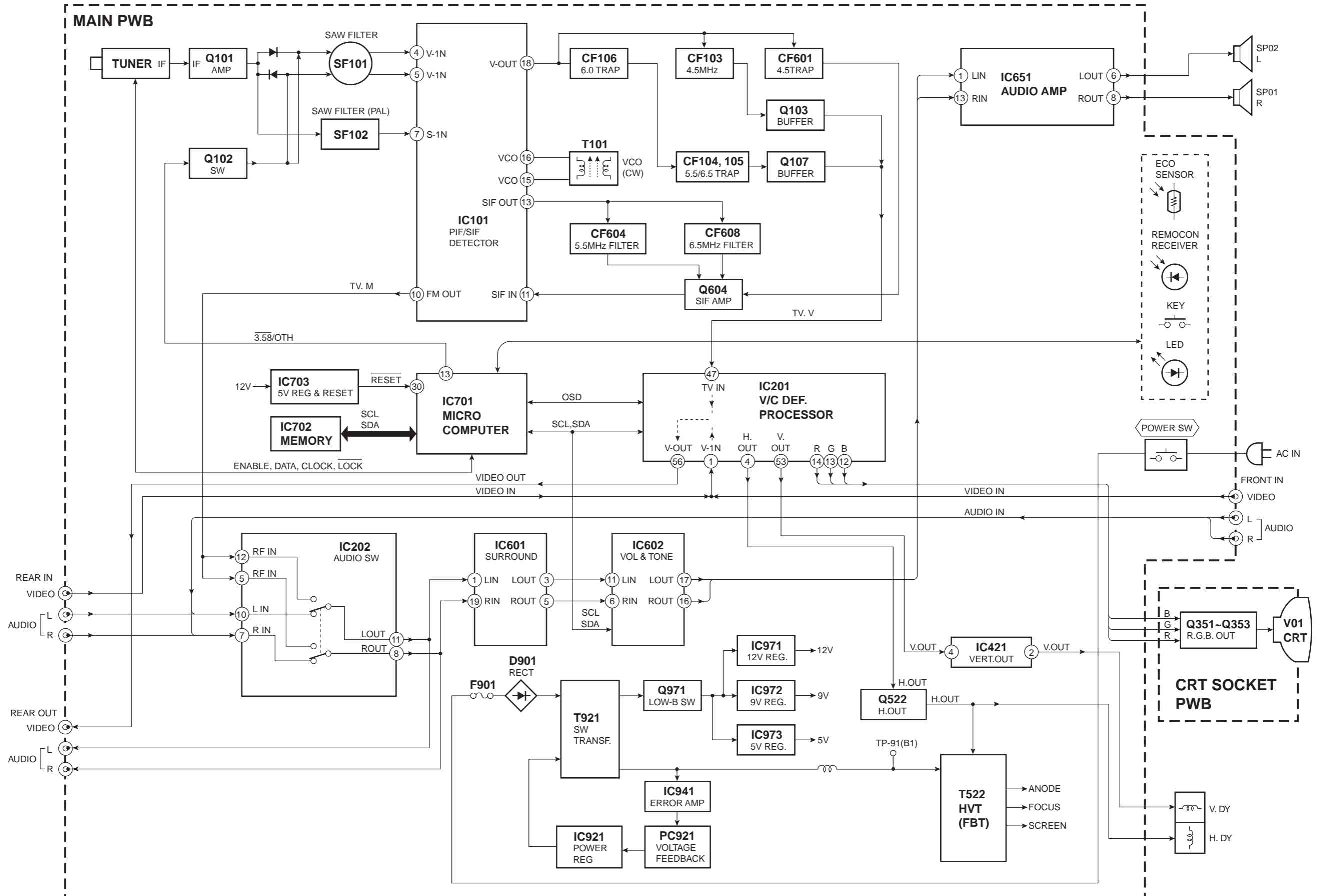

CIRCUIT DIAGRAMS MAIN PWB CIRCUIT DIAGRAM (1/3)

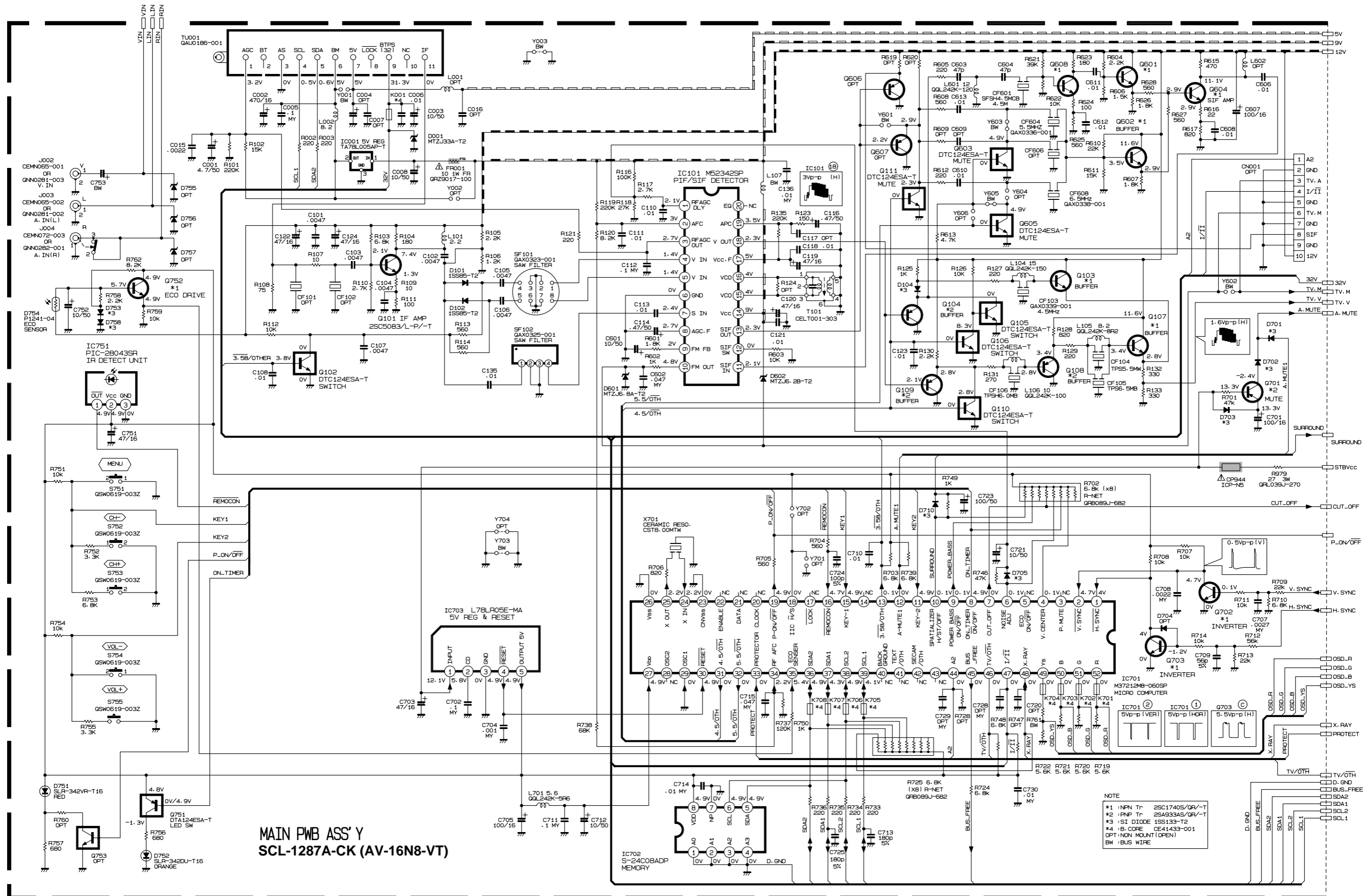

MAIN PWB ASS'Y SCL-1287A-CK (AV-16N8-VT)

NOTE

- *1 :NPN Tr 2SC1740S/QR-T
- *2 :PNP Tr 2SA933AS/QR-T
- *3 :SI DIODE 1SS133-T2
- *4 :B CORE CE41433-001 OPT-NON MOUNT(OPEN)
- BW :BUS WIRE

MAIN PWB CIRCUIT DIAGRAM (2/3)

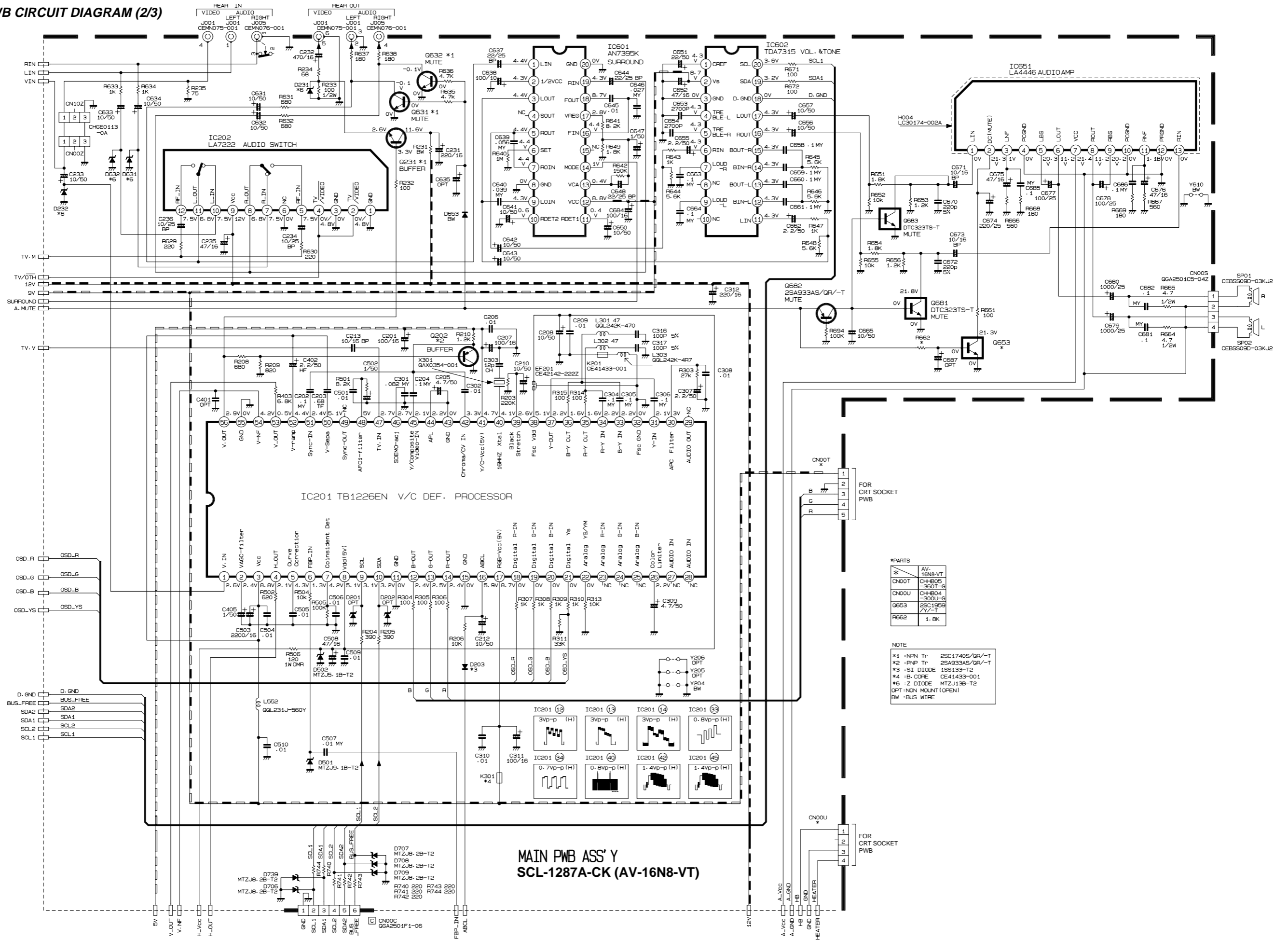

MAIN PWB CIRCUIT DIAGRAM (3/3)

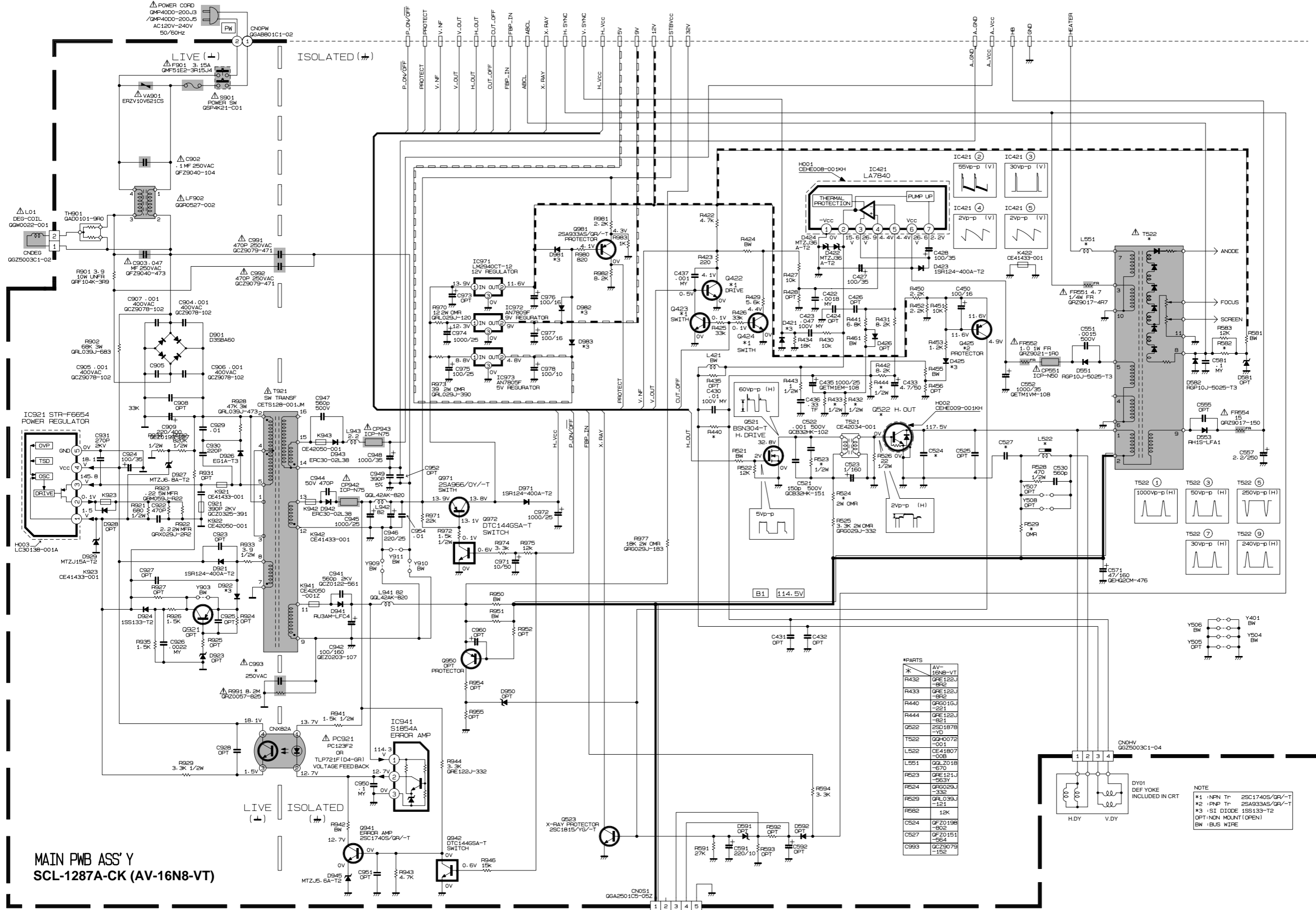

MAIN PWB ASS'Y
SCL-1287A-CK (AV-16N8-VT)

CRT SOCKET PWB CIRCUIT DIAGRAM

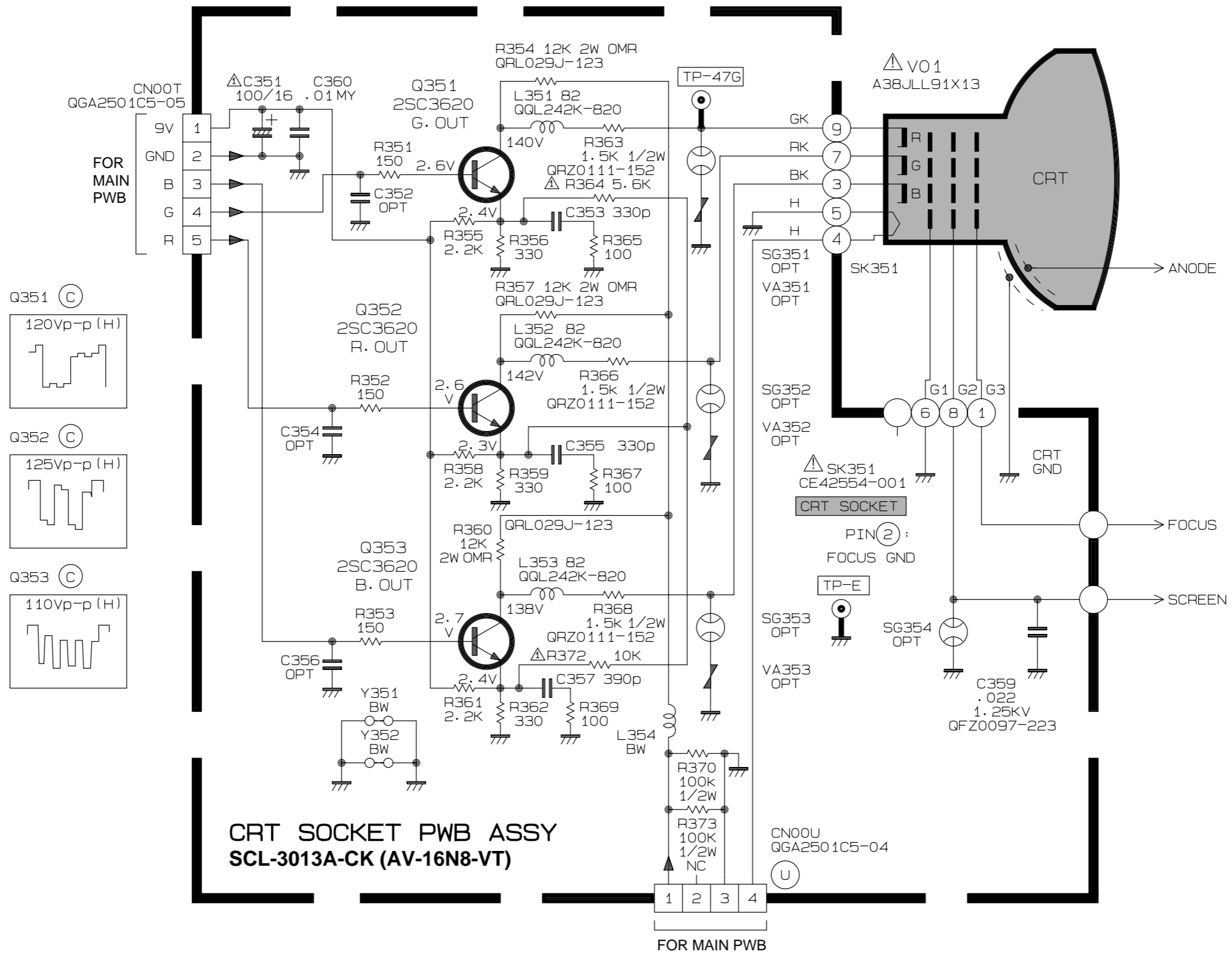

PATTERN DIAGRAMS MAIN PWB PATTERN

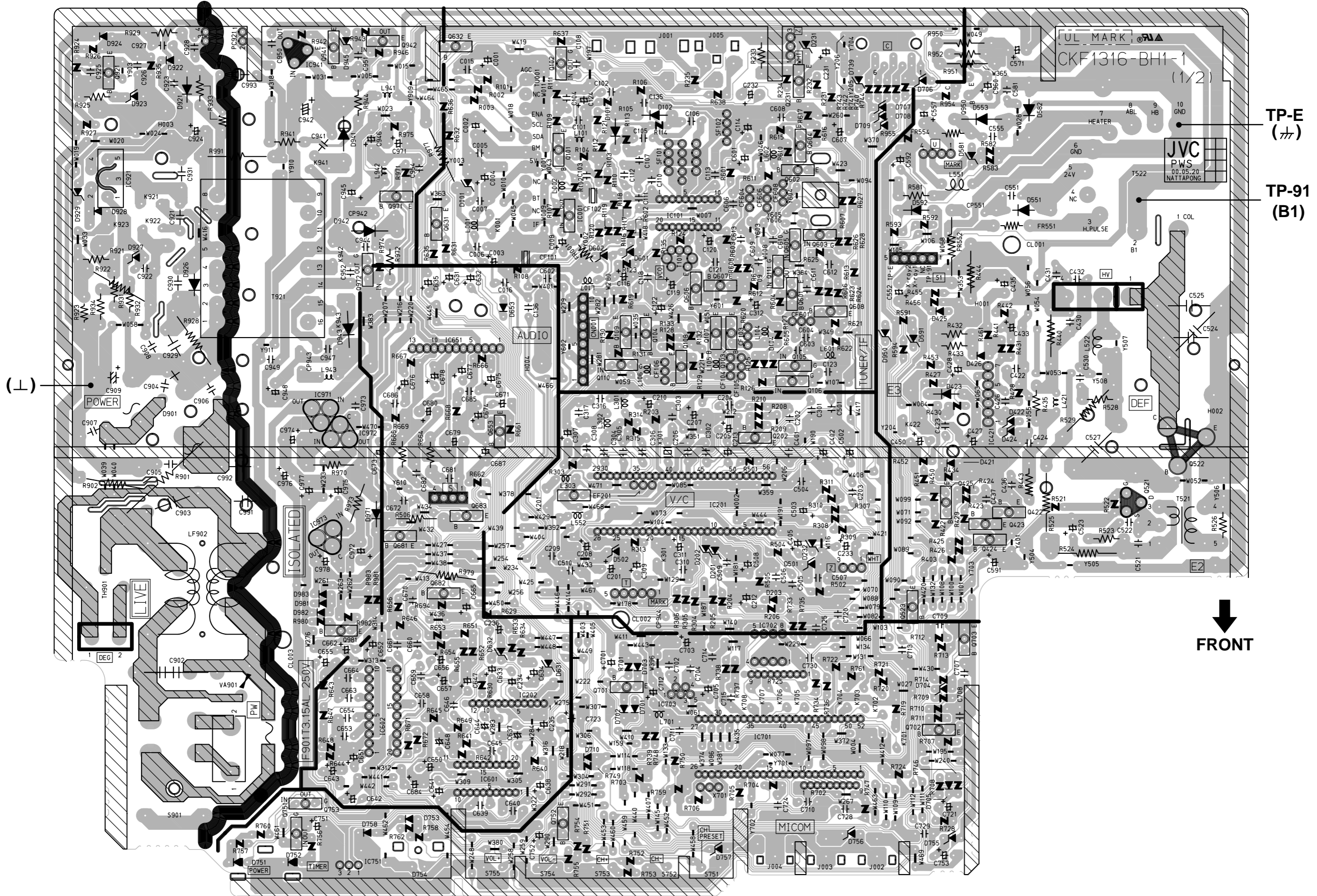

CRT SOCKET PWB PATTERN

↑ TOP

($\frac{1}{11}$)

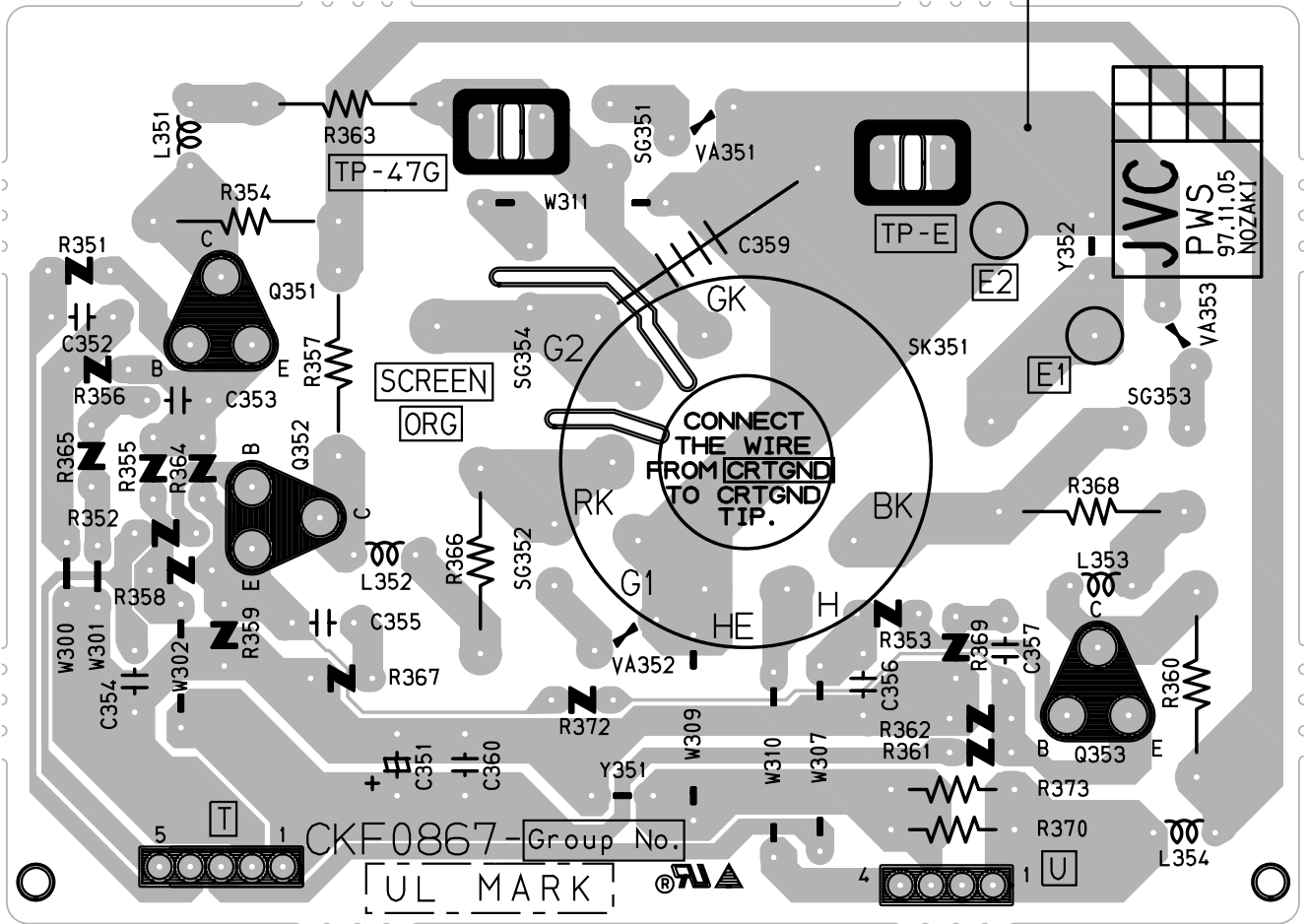



JVC

VICTOR COMPANY OF JAPAN, LIMITED
TELEVISION RECEIVER DIVISION 1106 Heta, Iwai-city, Ibaraki-prefecture, 306-0698, Japan